

• 10HP Eurorack Module • Built & designed in Belgium • [www.shakmat.com](http://www.shakmat.com)



# Shakmat Aeolus Seeds Building Guide

# Table of contents

- 1. Preamble ..... 2
- 2. Component list & necessary tools ..... 3
- 3. PCB details ..... 4-5
- 4. PCB Stacking ..... 6-7
  - 4.1 Headers bottom PCB ..... 6
  - 4.2 Headers Tactical Plan ..... 7
- 5. Top PCB assembly ..... 8
  - 5.1 Back ..... 8
    - 5.1.1 Power Header ..... 8
  - 5.2 Front ..... 9
    - 5.2.1 Push buttons ..... 9
    - 5.2.2 Jack connectors ..... 10
    - 5.2.3 Potentiometers ..... 11
    - 5.2.4 LEDs ..... 12
- 6. Front panel & LEDs ..... 17
- 7. Nuts & caps ..... 18
- 8. Powering ..... 19
- 9. Calibration ..... 20
- 10. Testing ..... 21

# 1. Preamble

Thank you for purchasing a Shakmat DIY kit !

We spare no effort in our kit packing process to prevent any mistakes or missing parts. In this document as well, we do our best to describe the assembly process in the most practical and comprehensive way. If by any chance there is a missing/damaged part in your kit or if you have any suggestion, feel free to contact us via [shakmat.com](http://shakmat.com).

The assembly process will be dramatically simplified if you follow the order defined by this building guide. We tested various orders of steps before finding the most convenient, and the one presented here is the best!

## 2. Component list & necessary tools

### Pack 1

- 4x Tactile switch
- 4x Tactile switch caps
- 4x Green LEDs
- 7x Amber LEDs
- 1x 2x5 pin power header
- 2x 4 pin male header
- 2x 4 pin female header
- 3x 8 pin male header
- 3x 8 pin female header
- 2x 20 pin male header
- 2x 20 pin female header
- 2x Metal potentiometers
- 2x Metal potentiometer nuts
- 15x Jack connectors
- 15x Jack connector nuts
- 7x White LEDs
- 2x M3 screws
- 1x MCP4921 (in plastic tubing)
- 1x 2x4 IC socket (in plastic tubing)

### Pack 2

- 1x Top PCB
- 1x Bottom PCB
- 1x Tactical Plan

### Loose parts

- 2x Black rubber knobs
- 1x Power cable
- 1x User manual

### 3. PCB details

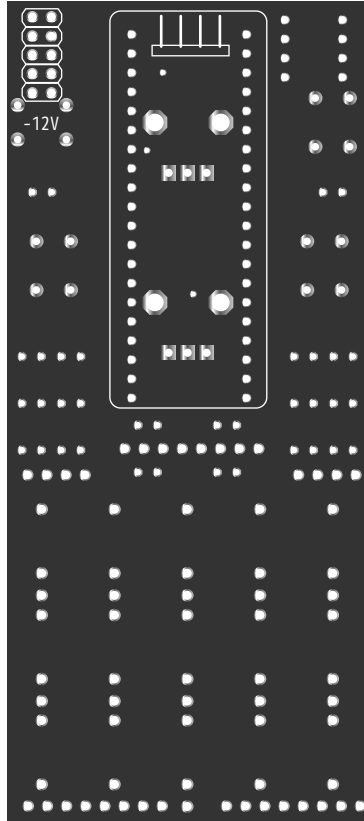
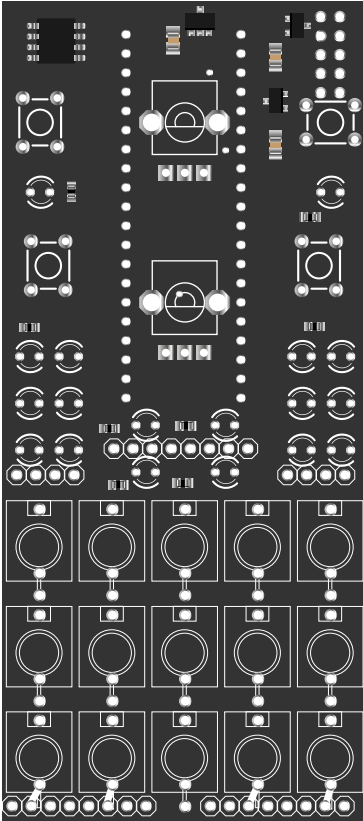

**Top PCB**  
Front & back

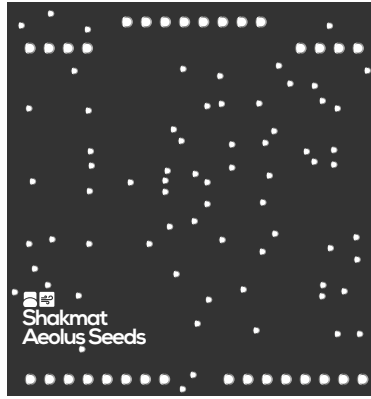
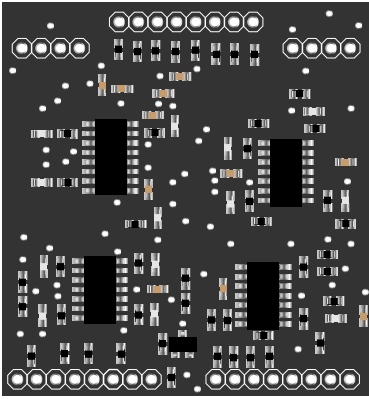

**Bottom PCB**  
Front & back

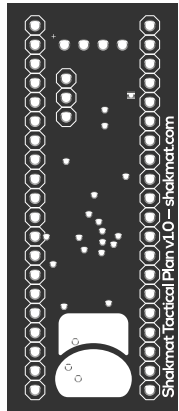
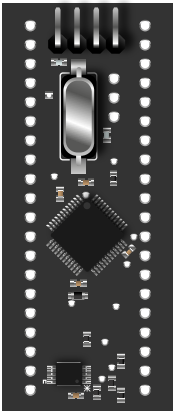

**Tactical Plan**  
Front & back

# 4. PCB stacking

## 4.1 Headers bottom PCB

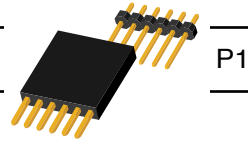

Headers are used to stack the two PCBs together, There are three pairs of 8 pin male & female headers and two 4 pin pairs. First assemble all the headers with their mate and place them on the bottom PCB, female side down. Then assemble the two boards together and solder one pin, on each side, for each header. Once the PCBs are held together and correctly aligned, you can solder all the remaining points. If the PCB are not aligned re-heat the leg of the faulty header and correct alignment.

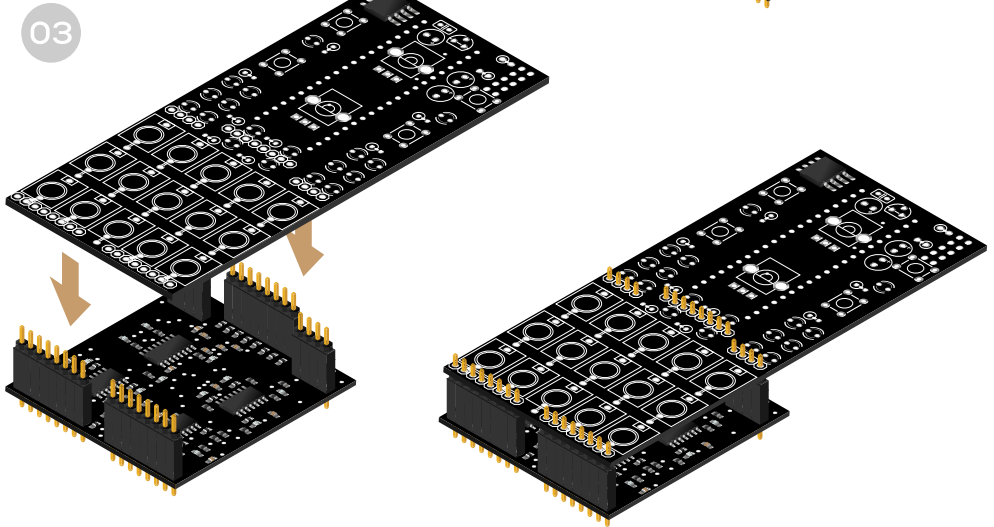
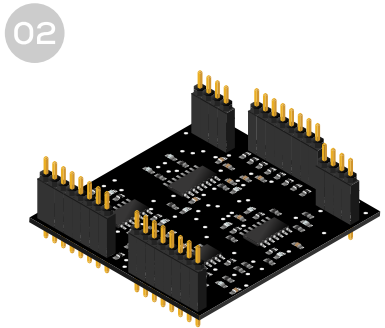
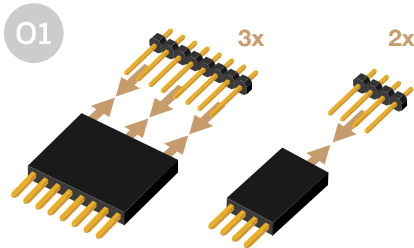

---

## 4.2 Headers Tactical Plan

---

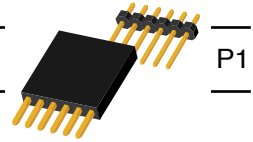

Now, we are going to stack the Tactical Plan with the previous step PCB pair. For this we use two 20 pin pairs of male & female headers. First assemble the headers, then place them on the Tactical Plan, male side down. Then assemble the two boards together and solder one pin, on each side, for each header. Once the PCBs are held together and correctly aligned, you can solder all the remaining points.

Be very careful with the soldering of the female part of the headers. Once all the components will be in place, those solder points will be very hard to reach. When everything is well soldered, disconnect the two boards and proceed to the next step with the top PCB.

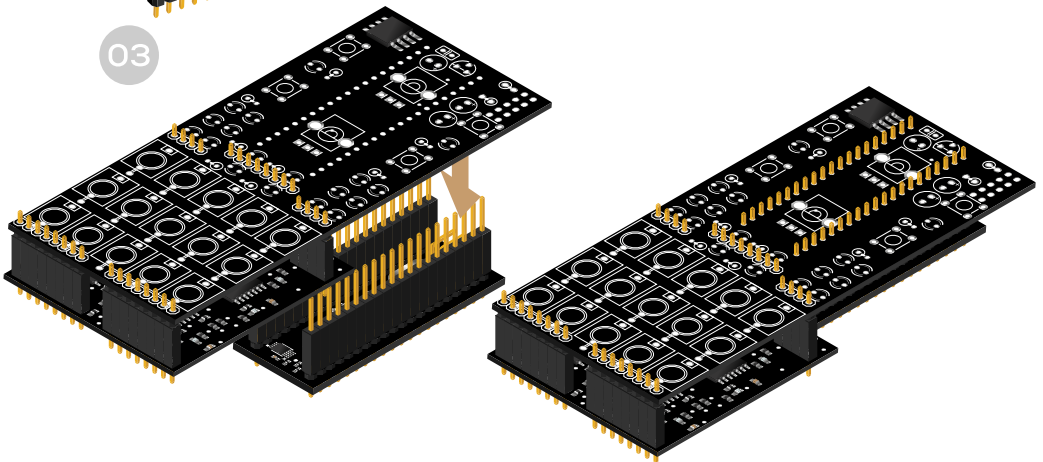
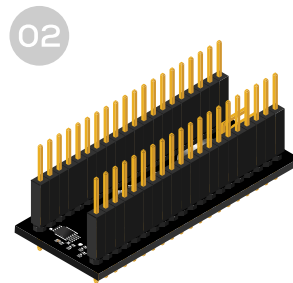
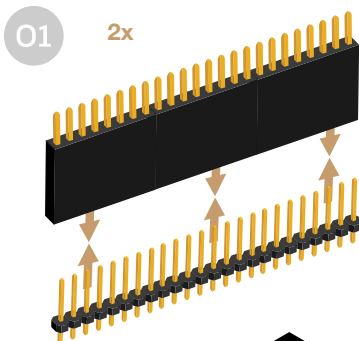

# 5. Top PCB assembly

## 5.1 Back

### 5.1.1 Power header

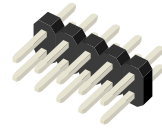

P1

Place the power header, short pin side in the hole and solder only one of the pins. Check the alignment and correct with the same method as for a single row header. Then, once your component is upright and flat with the PCB, solder the remaining pins.

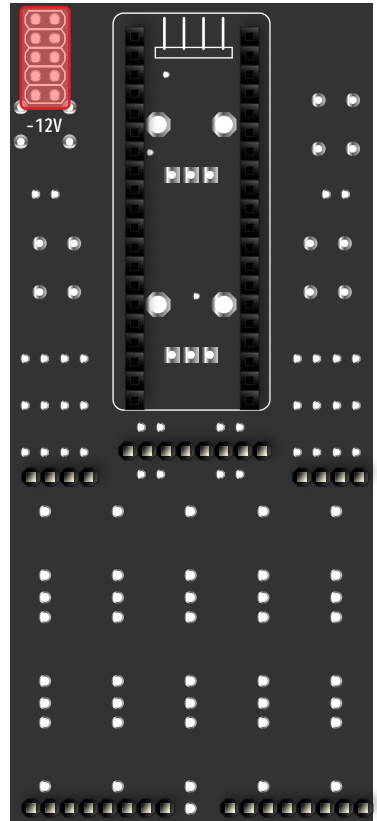

---

## 5.2.1 Push buttons (x4)

---

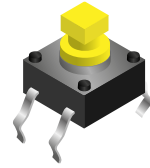

P1

---

It's very important to solder the four push buttons flat with the PCB. If they are crooked or not thoroughly pushed through, the caps won't pop properly through the front panel and the buttons will be hard to press.

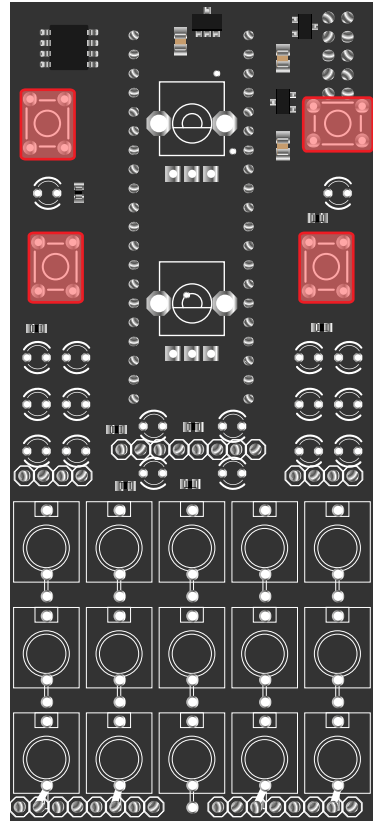

## 5.2.2 Jack connectors (x15)

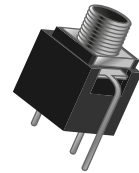

P1

It's time to solder the fifteen jack connectors. Four of them has their outer ground leg soldered on an adjacent pin from the previously soldered header.

For these four jacks, you need to cut about three millimeters off the outer ground leg (as shown in the picture above) in order to be able to solder correctly to the adjacent pin header.

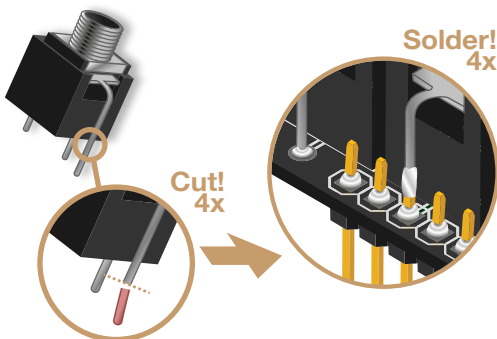

Be sure to lay the jacks completely flat on the PCB before soldering. If those jacks aren't perpendicular, the front panel will be very hard to mount.

If one of the jack is not perfectly perpendicular with the PCB, you can reheat the pads and push it down with your thumb to re-align.

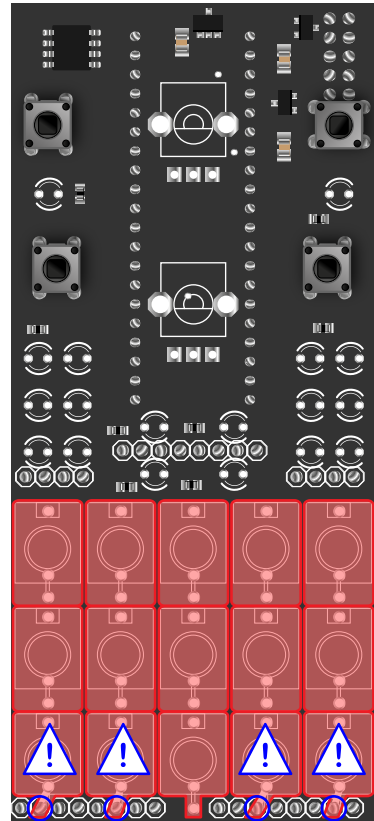

### 5.2.3 Potentiometers (x2)

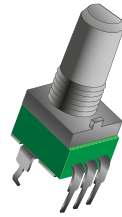

P1

Before soldering, you have to cut a little metal piece off the top of each potentiometer, as shown in the picture. This little stud prevents the front panel from sitting properly. Use some small & sharp cutting pliers for this task.

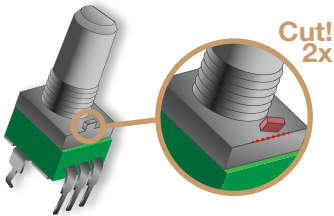

Then place the 2 potentiometers, push them flat all the way through the PCB, and solder.



---

## 5.2.4 LEDs (x18)

---

P1

Placing the LEDs requires a specific orientation due to their polarity. The long legs are the positive side and they all go into the left holes of the PCB. Note that the green LEDs are differentiated by a little dash of green marker on one leg. The same thing is done on the amber LEDs with a dash of red marker.

Place all the LEDs through the PCB paying attention to the colors and orientations but don't solder them now.

### LED POLARITY!



---

Green LEDs ( **A** x4)

---

P1

---

Amber LEDs ( **B** x7)

---

P1

---



White LEDs ( **C** x7)

---

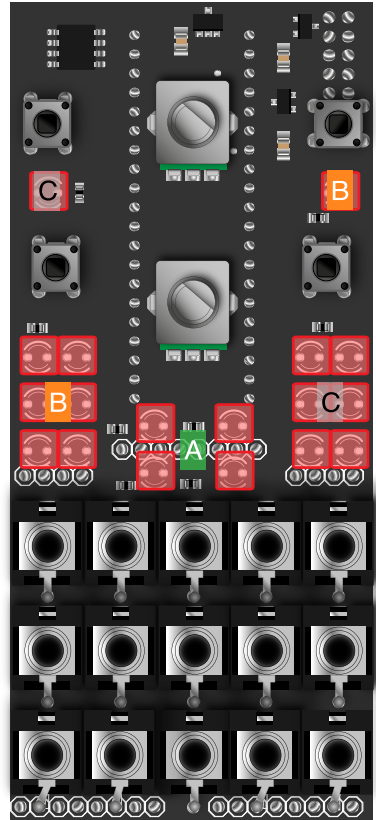
P2



## 6. Front panel and LEDs

Potentiometer nut		P1
Jack nuts (x3)		P1



Place some masking tape over every LED hole on the front panel. Be aware of not blocking any other component's hole with the tape. The LEDs are special flat top models intended to be mounted flush with the front panel. The masking tape will help you to do this neatly.

Once the panel is ready, mount it on the top PCB and secure it with 4 nuts: 1 on the Time potentiometer and one on Time, Mode & Sum jack connectors.

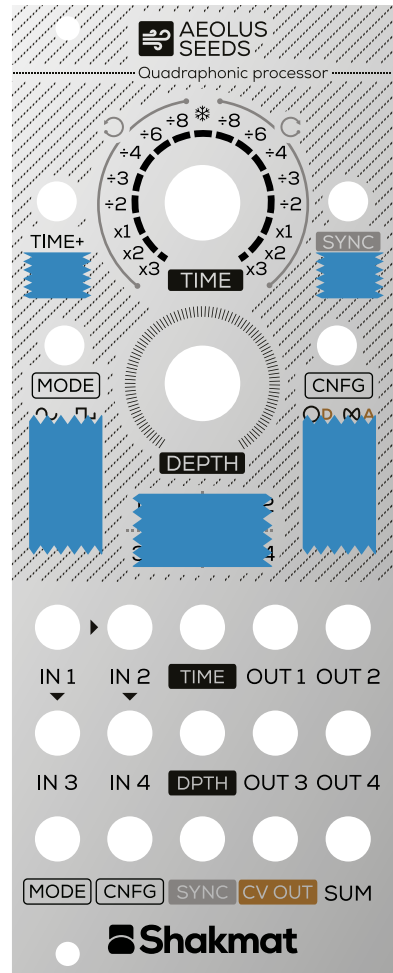

Check the alignment of the top PCB and front panel, the two must be parallel. Now, push every LED through their holes until they sit flush with the panel and stick to the tape. Once they are all in place, you can solder them and trim their legs.



# 7. Nuts & caps

- \_\_\_\_\_ Potentiometer nuts  \_\_\_\_\_ P1
- \_\_\_\_\_ Jack nuts (x12)  \_\_\_\_\_ P1

Screw all the nuts, on the big metal potentiometer and mini-jacks.

- \_\_\_\_\_ Push button cap (x4)  \_\_\_\_\_ P1
- \_\_\_\_\_ Pot knobs (x2)  \_\_\_\_\_ LP

Push the potentiometer knob and push button caps on place.



## 8. Powering

Now let's place the module in your system and test it. Plug in the power cable and make sure the red side matches the -12V on the PCB. We recommend you to start the module in *Full calibration mode*. To do so, hold the CNFG button pressed while powering on the module. The SYNC LED should start to blink. If so continue to the next chapter. If the LED is not responding, turn your system off and on again to re-start the module in normal mode. Press the mode button and the first mode LED should blink or be on. If no LED is on or blinking, the module is probably not powering up. You might re-check the power cable orientation, the orientation of all the LEDs, electrolytic capacitors and the Tactical Plan. If everything is correctly oriented, double check all your solder points.

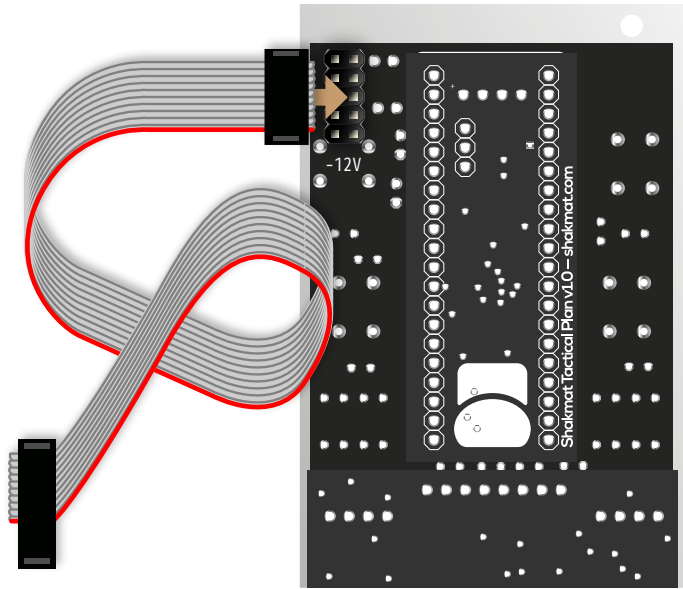

## 9. Calibration

Your module has a blinking SYNC LED ? So, it's in *Full calibration mode*. This mode consists of two chained calibration procedures: the Time potentiometer calibration and the CV inputs calibration. Before starting the procedure, make sure that no cable is plugged in the Aeolus Seeds.

First, you have to set the Time potentiometer to every blank spot of the front panel print around the potentiometer, and press the Sync button once. So, adjust the Time potentiometer on the empty spot between the x3 and x2 zones of the left side and press the SYNC button. Then, adjust the potentiometer on the empty spot between the x2 and x1 zones, and press the SYNC button again.

You will have to repeat this operation for every spot between two Time potentiometer zones, starting from fully counter-clockwise. The procedure will include a total of 16 measures. After the 16th measure is made, the module will process to the CV input calibration which is automatic and only takes a couple of seconds. During this period the SYNC LED will stop blinking and stay on. Be sure that no cable is connected to the inputs and outputs of the module. Once the routine is performed, the module will start normally.

This *Full calibration mode* also resets the current state of the module to the factory settings. If later, you want to access it again, you can again power up your module while maintaining the CNFG button pressed.

## 10. Testing

If the calibration procedure went well, the module will start normally, the first MODE and CNFG LEDs will be on, and the activity LEDs will light up.

1. First we will test all the buttons and LEDs, pushing a button has a direct action to the the LED(s) next to it. If you cannot scroll the CNFG or MODE menu entirely, there might be a problem with the CV inputs. The CV input calibration process does not fail if the procedure is respected, so you might have a closer look at the CV inputs jack socket and PCB to PCB headers solder pins. Activity LEDs should be all light up, flashing or dimming.

2. Go to the first mode (Quadrature Sine), set the Depth potentiometer all the way to the right and set the Time potentiometer at noon ( freeze position). The modulation should stop. Insert a positive voltage in the Time CV Input, the modulation should start again. Remove the cable from the Time CV input, the 4 Activity LEDs should be on (no light variation at all). Insert a positive CV in the Depth input, the Activity LEDs should dim again.

If the CV inputs are not responding correctly, re-check their jack socket solder points and all the PCB to PCB headers solder points. If the LEDs are not working, check their orientation. If the potentiometers are not working, re-check the solder points. Also carefully check all the solder points linking the Tactical Plan to the Top PCB.

3. Make sure that your module is set to the first mode (Quadrature Sine) and first configuration (Circle). Insert a positive voltage in the Mode CV input, the Mode LEDs should change. Same for the CNFG LEDs.

If the LEDs are not working, check their orientation and soldering.

If the CV inputs is not responding correctly, check their jack socket solder points and the PCB to PCB solder points.

4. We will now test all the inputs and outputs. Make sure that your module is set to the first mode (Quadrature Sine), turn the Depth potentiometer completely off. Send an audio signal in the first input and check the first and Sum output. Repeat this operation for the second, third and fourth CV input.

If you don't have any audio from the outputs, you might have a closer look at the corresponding inputs and outputs soldering points and the PCB to PCB solder points.

5. Finally, we test the CV outputs. To do so, set the module in ( ) Decay mode and first configuration (Circle). You should have a repeating decay envelop at the CV output. If the CV output does not give any signal, take a closer look at the jack soldering points and the PCB to PCB solder points.

If after this debugging you still have problem,  
don't hesitate to contact us at [support@shakmatmodular.com](mailto:support@shakmatmodular.com)

[www.shakmat.com](http://www.shakmat.com) •

 **Shakmat**